

TIMKEN**The Timken Company**

4500 Mt Pleasant St. NW

N. Canton, OH 44720

Phone: (234) 262-3000

E-Mail: CustomerCAD@timken.com • Web site: www.timken.com**Part Number 61809-2RS, Thin Section Ball Bearings (61700, 61800, 61900)**

Timken's deep groove ball bearings deliver reliable performance in a wide range of applications and conditions. With super-finished raceways and controlled geometries, our premium design helps ensure consistent quality.

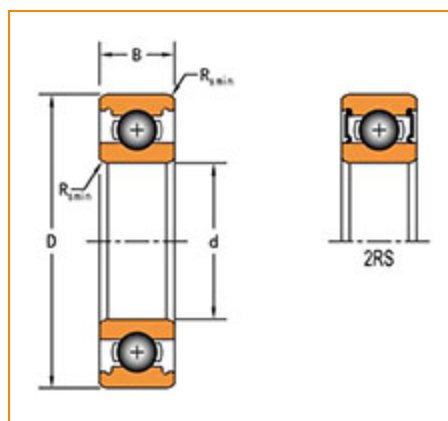

[Specifications](#) | [Dimensions](#) | [Basic Load Ratings](#) | [Factors](#)

Specifications

Clearance	C0 (Normal)
Bore Size d	45.000 mm
Features	Contact Seals
Weight	0.034 Kg

Dimensions

Outside Diameter D	58.000 mm
Outside Ring Width B	7.000 mm
Radius R_s min	0.300 mm



Basic Load Ratings

Cr - Dynamic Load Rating	6.2 kN
C0r - Static Load Rating	5.40 kN

Factors

Grease Limiting Speed	11000 rpm
Oil Limiting Speed	13000 rpm

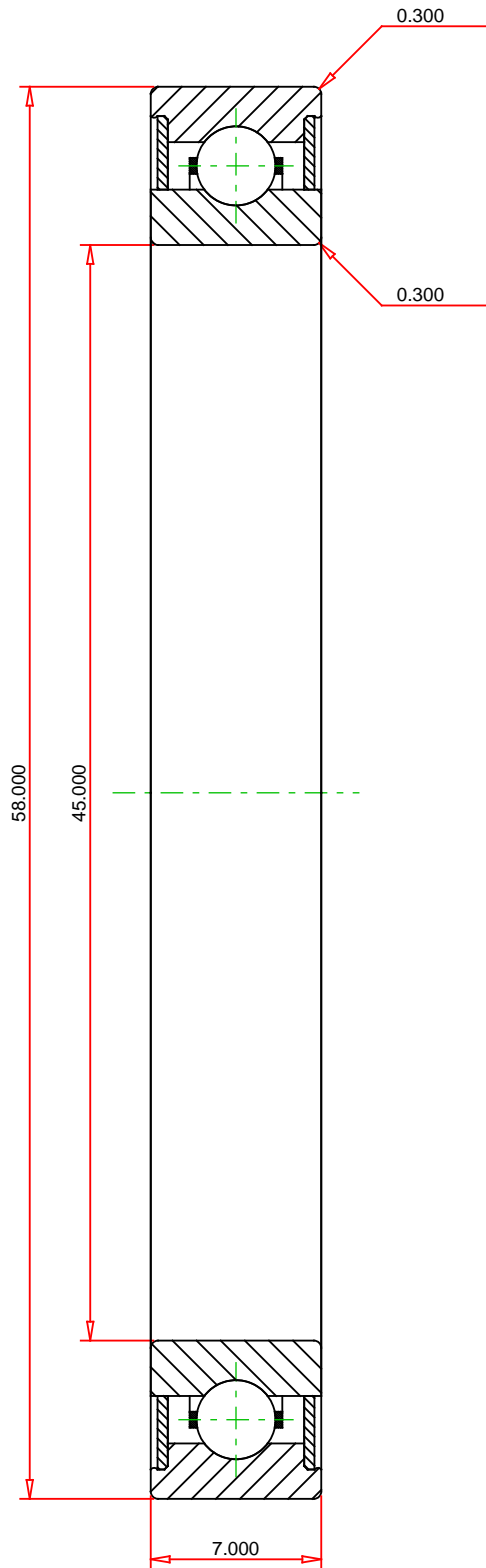

METRIC UNITS

Weight 0.034 kg

TIMKEN®

THE TIMKEN COMPANY
NORTH CANTON, OHIO USA

61809-2RS
Thin Section Ball Bearings (61700, 61800, 61900)

Dynamic Load Rating 6200 N
Static Load Rating 5400 N

Every reasonable effort has been made to ensure the accuracy of the information contained in this writing, but no liability is accepted for errors, omissions or for any other reason.

FOR DISCUSSION ONLY